

ULYSSES™ SIDECASE AND TOPCASE KIT

GENERAL

Kit Number

92030-05Y

Models

This kit fits 2006 and later Buell® Ulysses model motorcycles.

Additional Parts Required

NOTE

Proper installation of Topcase mounting bracket requires installation of both Sidecase mounting brackets. Installing without both Sidecase mounting brackets can allow Tail Section casting to break.

⚠ WARNING

Do not exceed the motorcycle's Gross Vehicle Weight Rating (GVWR) or Gross Axle Weight Rating (GAWR). Exceeding these weight ratings can affect stability and handling, which could result in death or serious injury. (00016e)

- GVWR is the sum of the weight of the motorcycle, accessories, and the maximum weight of the rider, passenger and cargo that can be safely carried.
- GAWR is the maximum amount of weight that can be safely carried on each axle.
- The GVWR and GAWR are shown on the information plate, located on the frame down tube.

A Service Manual for the year and model motorcycle is available at any Buell Dealer.

Loctite® 271 (red) (Part Number 94671-97) is available at any Buell Dealer.

Kit Contents

See Figure 6 and Table 1, Figure 7 and Table 2.

INSTALLATION

NOTE

Loctite 271 (red) must be applied to all fasteners before installation.

Install Sidecase Brackets

1. See Figure 6. Insert a 1/4-20 x 5/8 inch hex head fastener (6) and a 1/4 inch lockwasher (8) through the lower forward mount of the bracket (C) and into the mount point behind the passenger foot peg bracket. Keep fastener loose at this time.

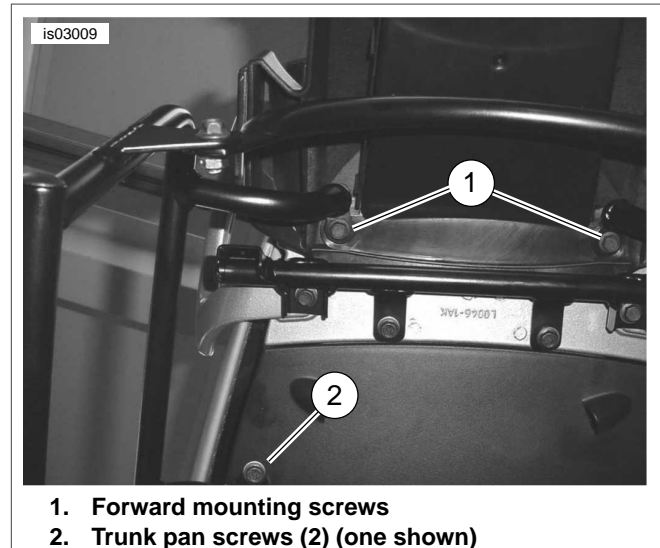

Figure 1. License Plate and Trunk Pan Screw Removal

2. See Figure 1. Remove the two forward mounting button head fasteners (1) holding the license plate bracket to the tail (under license plate bracket).

NOTE

All Belleville lock washers must be installed with the inside diameter making contact with the bolt head.

3. Remove the two button head fasteners holding the trunk pan to the tail loop on each side.
4. See Figure 6. Starting with the left sidecase bracket (3), insert a 1/4-20 x 2.0 inch hex head fastener (16) and a 1/4 inch lock washer (8) through the upper rear mount of the bracket (A) and into the forward mounting point of the license plate bracket. Hand tighten fastener at this time.
5. Insert a 1/4-20 x 1.0 inch hex head fastener (7) and a 1/4 inch lockwasher (8) through the upper front mount of the bracket (B) and into the left side trunk pan mounting point. Hand tighten fastener at this time.

NOTE

The passenger footpeg supports can be loosened to give additional clearance for mounting the sidecase brackets. Tighten the passenger footpeg supports 132-144 in-lbs (15-16 Nm).

6. Repeat Steps 3 through 5 for right sidecase bracket installation.
7. With both left (3) and right (4) sidecase brackets installed, install X-brace (5) between the left and right brackets with two 1/4-20 x 5/8 inch hex head fasteners (6), and two 1/4-20 locknuts (9).

NOTE

When tightening fasteners, make sure there is solid contact between the brackets and the mounting points on the motorcycle. Also, all Belleville lock washers must be installed with the inside diameter making contact with the bolt head.

8. Tighten all fasteners to 108-120 **in-lbs** (12.0-13.5 Nm).
9. Install protective tape (10) to the left and right sidecase tube structures in locations indicated (E).

Install Sidecase Luggage Bags

1. Place key (12) in sidecase locking latch (G) in open position. Open latch.
2. Attach Sidecase to mounting bracket by positioning rectangular mounting surface inside rectangular area of sidecase bracket (3). Slide sidecase as far rearward as possible.
3. Mate locking latch (G) with attachment point (F) and close latch. Rotate key into closed position and remove key. Check that sidecase and latch are properly seated and locked.
4. Repeat procedure for right sidecase

WARNING

Check that saddlebags are completely engaged by pulling lower portion of saddlebag outward (away from bike) after installation. If saddlebags are not completely engaged, they can fall off while riding and cause loss of control, which could result in death or serious injury. (00074a)

Install Reflectors

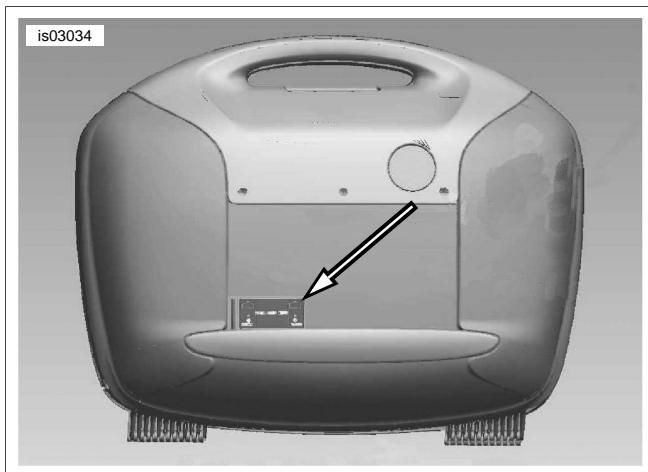

Figure 2. Left Side Case Reflector Mounting Location

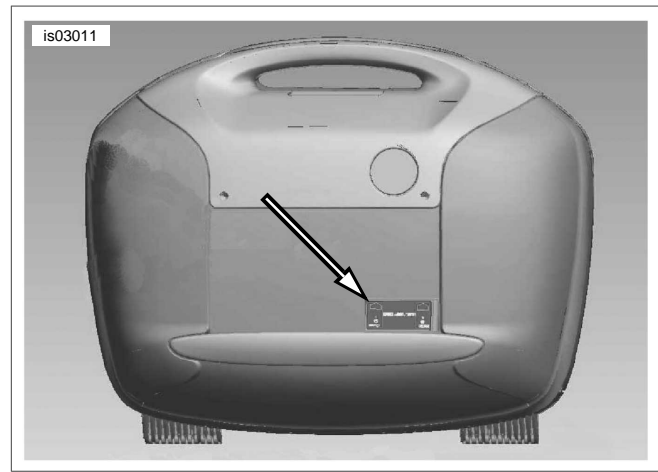

Figure 3. Right Side Case Reflector Mounting Location

1. See Figure 2 and Figure 3. Using isopropyl alcohol, clean the surface of the sidecase where the reflector will be mounted.
2. Remove the adhesive backing from the left side reflector and install per Figure 2 and Figure 3 with orientation arrow on the reflector pointing up. Hold reflector firmly against saddlebag for 10-15 seconds. Repeat for right side reflector.

Return the Motorcycle to Service

NOTE

Record the key code number off of the key so replacement keys can be ordered in the event of loss.

WARNING

Do not open storage compartments while riding. Distractions while riding can lead to loss of control, which could result in death or serious injury. (00082a)

WARNING

Do not exceed saddlebag weight capacity. Put equal weight in each bag. Too much weight in saddlebags can cause loss of control, which could result in death or serious injury. (00383a)

NOTE

Maximum load per motorcycle case 22 lbs (10 Kg). Maximum load in Topcase 11 lbs (5 Kg). Do not exceed speed 80 mph (130 km/h), with these cases and/or topcase mounted. At higher speeds air turbulence or crosswinds may effect motorcycle stability. When driving with motorcycle, all locks must be locked.

INSTALLATION OF TOPCASE

Prepare the Motorcycle

Follow the Owner's Manual instructions to remove the seat.

Install the Mounting Bracket

1. See Figure 4. Remove the two button head fasteners holding the forward lower grab handle mount points (1).
2. Remove the two button head fasteners in the middle of the tail loop holding the seat latch (2).

NOTES

Locite 271 (red) must be applied to all fasteners before installation.

All Belleville lock washers must be installed with the inside diameter making contact with the bolt head.

3. See Figure 7. From the kit, install the cross bar mount (3) to the underside of the seat pan using four 1/4-20 x 1.0 inch fasteners (9) and four 9/16 inch O.D. Belleville washers (4) to the cross bar inner mounts (E) and outer mounts (D). Thread the fasteners in but do not tighten at this time.
4. From the kit, install the topcase mounting bracket (2) upper mounts (B) to the grab handle (Figure 5, item 2) by inserting two 5/16-18 x 1.0 inch hex head fasteners through 11/16 inch O.D. Belleville washers and mount points (B) into the forward lower grab handle (Figure 5, item 1). Thread the fasteners in but do not tighten at this time.
5. Install two 1/4-20 x 5/8 inch hex head fasteners (8) with 1/4 inch nuts (7) at the interface between the cross bar (3) and mount bar arms (C). Thread the bolt in but do not tighten at this time.
6. Tighten the forward lower grab handle point fasteners (1/4-20 x 1.0 inch) to 108-120 **in-lbs** (12.0-13.5 Nm).
7. Tighten the seat latch mount point fasteners (1/4-20 x 1.0 inch) to 60 **in-lbs** (6.8 Nm).
8. Tighten the upper rear grab handle mount point fasteners (5/16-18 x 1.0 inch) for the topcase to 19-20 **ft-lbs** (25.8-27.0 Nm).
9. Tighten the cross bar to mount bar fasteners (1/4-20 x 0.625 inch) to 108-120 **in-lbs** (12.0-13.5 Nm).
10. Refer to the owners manual and verify that the three position tail rack is functioning properly.
11. See Figure 7. Remove the backing from the three protective tape (6) pieces and install onto mounting bracket (2) areas as shown (A).

WARNING

After installing seat, pull upward on seat to be sure it is locked in position. While riding, a loose seat can shift causing loss of control, which could result in death or serious injury. (00070b)

Follow the Owner's Manual instructions to install the seat.

Install Topcase to Mounting Bracket

1. Place key in topcase locking latch in open position. Open latch.
2. Attach topcase to mounting bracket by centering top case on mounting bracket (2) and sliding as far forward as possible.
3. Mate locking latch with attachment point and close latch. Rotate key into closed position and remove key. Check that top case and latch are properly seated and locked.

Open and Close the Topcase

WARNING

Do not open storage compartments while riding. Distractions while riding can lead to loss of control, which could result in death or serious injury. (00082a)

WARNING

Do not exceed Topcase weight capacity. Too much weight can cause loss of control, which could result in death or serious injury. (00482b)

Maximum load per motorcycle case 22 lbs (10 Kg). Maximum load in Top Case 11 lbs (5 Kg). Do not exceed speed 80 mph (130 km/h), with these cases and/or topcase mounted. At higher speeds air turbulence or crosswinds may effect motorcycle stability. When driving with motorcycle, all locks must be locked.

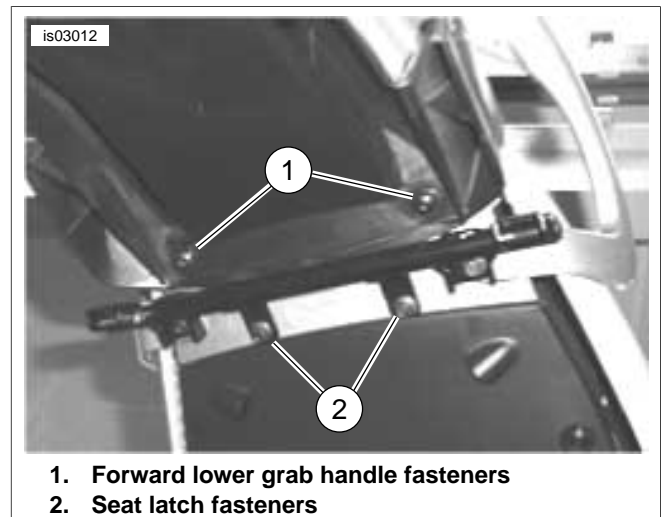

Figure 4. Grab Handle and Seat Latch Hardware

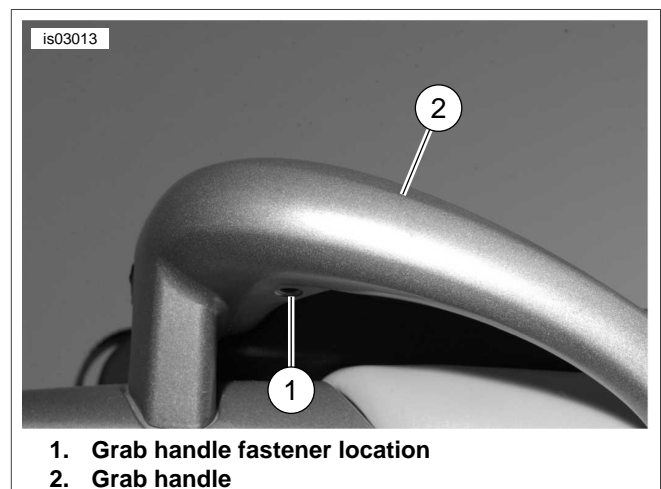

Figure 5. Grab Handle

SERVICE PARTS

is03015

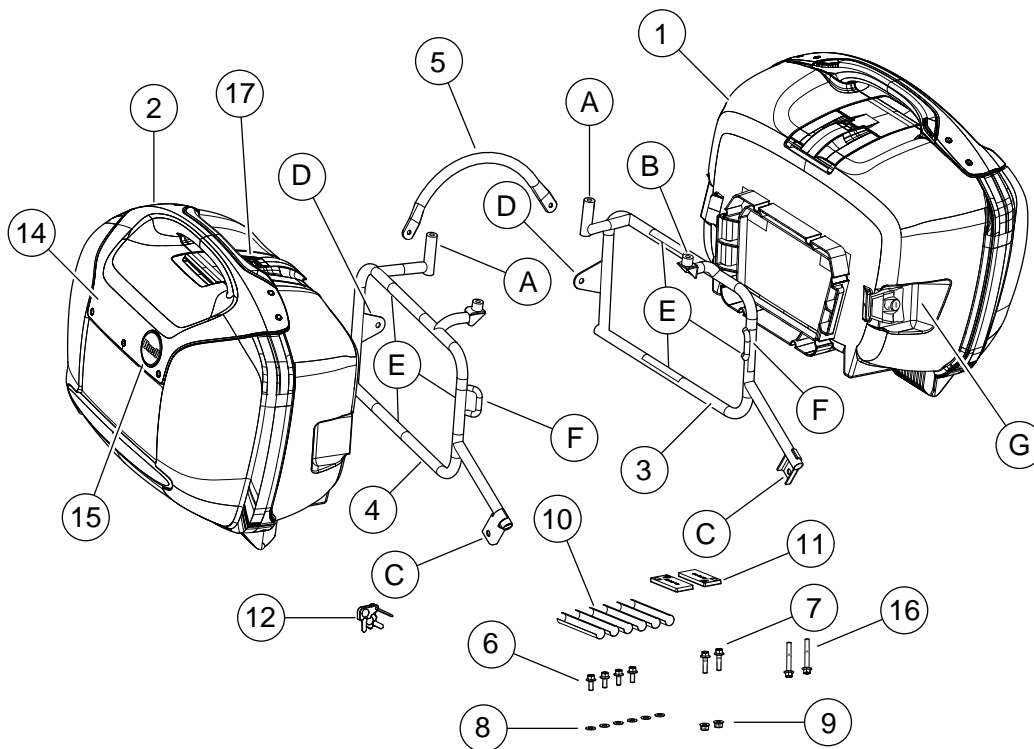

Figure 6. Service Parts: Ulysses Sidecase

Table 1. Service Parts: Ulysses Sidecase

| Item | Description (Quantity) | Part Number | Item | Description (Quantity) | Part Number |
|------|------------------------------|-------------|-----------------|---|-------------|
| 1 | Side case, left | 90081-05Y | 14 | Cosmetic cover | 90097-05Y |
| 2 | Side case, right | 90092-05Y | 15 | Buell emblem | 90098-05Y |
| 3 | Left hand bracket | 90085-05Y | 16 | 1/4-20 x 2.0 inch bolt (2) | 3114 |
| 4 | Right hand bracket | 90089-05Y | 17 | Sidecase latch service kit | 90114-06Y |
| 5 | X-brace bracket | 90090-05Y | Reference Items | | |
| 6 | 1/4-20 x 5/8 inch bolts (4) | 4536Y | A | Rear mounts, side case | |
| 7 | 1/4-20 x 1.0 inch bolts (2) | 4537Y | B | Trunk pan mounts | |
| 8 | Washers (8) | 7036 | C | Passenger foot peg mounts | |
| 9 | 1/4-20 lock nuts (2) | 7981 | D | X-brace mounts | |
| 10 | Protective tape (6) | 90118-05Y | E | Protective tape install locations | |
| 11 | Reflector (2) | 59259-90 | F | Side case luggage attachment point | |
| 12 | Key set | 90117-05Y | G | Side case locking latch (left side shown) | |
| 13 | Flat washers (2) (not shown) | 4566Y | | | |

NOTE

Record the key code number off of the key so replacement keys can be ordered in the event of loss. The key code consists of a 3 digit (XXX) number.

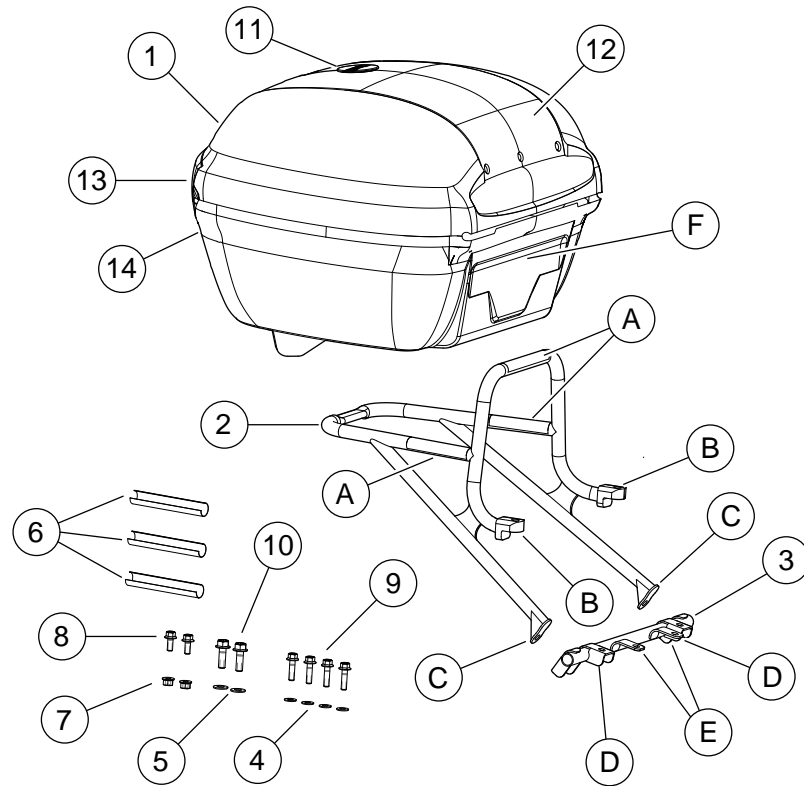

Figure 7. Service Parts: Ulysses Topcase

Table 2. Service Parts: Ulysses Topcase

| Item | Description (Quantity) | Part Number | Item | Description (Quantity) | Part Number |
|------|---|---------------------|------------------|--|-------------|
| 1 | Top case | Not Sold Separately | 12 | Cosmetic cover | 92143-05Y |
| 2 | Mounting bracket, lower | Not Sold Separately | 13 | Red lens | 92145-05Y |
| 3 | Cross bar mount | Not Sold Separately | 14 | Topcase latch service kit | 90110-06Y |
| 4 | Washer, Belleville (4) (9/16 O.D.) | 7083Y | Reference Items: | | |
| 5 | Washer, Belleville (2) (11/16 O.D.) | 7082Y | A | Protective tape location | |
| 6 | Protective tape (3) | 90118-05Y | B | Trunk pan mounts | |
| 7 | Flange nut (2) (1/4-20) | 7981 | C | Lower mounts | |
| 8 | Hex head flange screw (2) (1/4-20 X 0.625 inch) | 4536Y | D | Cross bar outer mounts | |
| 9 | Hex head flange screw (4) (1/4-20 x 1.0 inch) | 4537Y | E | Cross bar inner mounts | |
| 10 | Hex head flange screw (2) (5/16-18 x 1.0 inch) | 4567Y | F | Top case attachment point ("L" shaped catch) | |
| 11 | Buell emblem | 90098-05Y | | | |

NOTE

Record the key code number off of the key so replacement keys can be ordered in the event of loss. The key code consists of a 3 digit (XXX) number.